

FAG

★ QJ305-XL-TVP

Four-point contact bearing

Schaeffler ID:
0167424350000Four point contact bearing QJ3..-XL-TVP,
X-life, plastic cage

★ Preferred product

X-life

Technical information

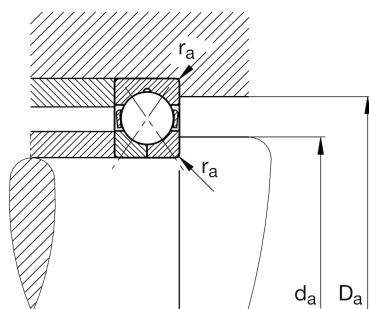
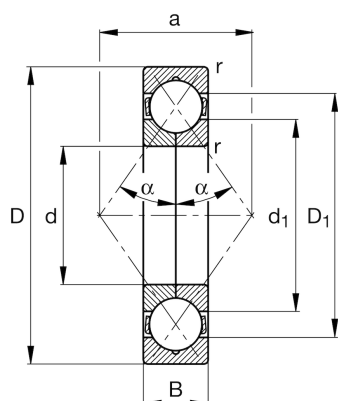

Temperature range

T_{min}	-30 °C	Operating temperature min.
T_{max}	120 °C	Operating temperature max.
	0,249 kg	Weight

Main Dimensions & Performance Data

d	25 mm	Bore diameter
D	62 mm	Outside diameter
B	17 mm	Width
C_r	46.500 N	Basic dynamic load rating, radial
C_{0r}	31.500 N	Basic static load rating, radial
C_{ur}	2.180 N	Fatigue load limit, radial
n_G	15.500 1/min	Limiting speed
n_{gr}	8.800 1/min	Reference speed

Dimensions

r_{min}	1,1 mm	Minimum chamfer dimension
D_1	49,5 mm	Shoulder diameter outer ring
d_1	37,5 mm	Shoulder diameter inner ring
a	31 mm	Distance between the apexes of the pressure cones
α	35 °	Contact angle

Mounting dimensions

$d_{a min}$	32 mm	Minimum diameter shaft shoulder
$D_{a max}$	55 mm	Maximum diameter of housing shoulder
$r_{a max}$	1 mm	Maximum fillet radius