

FAG

★ 234418-M-SP

Axial angular contact ball bearing

Schaeffler ID:
0190388950000Axial angular contact ball bearings 2344,
double direction, separable, restricted
tolerances

★ Preferred product

Technical information

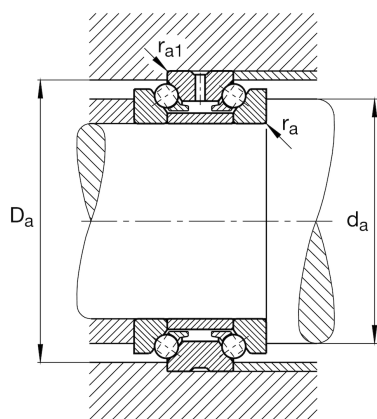
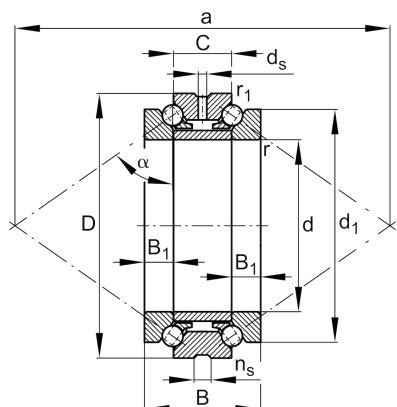

Temperature range

T_{min}	-30 °C	Operating temperature min.
T_{max}	150 °C	Operating temperature max.
	2,914 kg	Weight

Main Dimensions & Performance Data

d	90 mm	Bore diameter
D	140 mm	Outside diameter
B	60 mm	Width
C	30 mm	Width, outer ring
C_a	66.000 N	Basic dynamic load rating, axial
C_{0a}	213.000 N	Basic static load rating, axial
C_{ua}	18.200 N	Fatigue load limit, axial
$n_{G Grease}$	4.000 1/min	Limiting speed for grease lubrication
$n_{G Oil}$	5.300 1/min	Limiting speed for oil lubrication

Dimensions

d_1	123 mm	Rip diameter shaft washer
B_1	15 mm	Height wave disc
r_{min}	1,5 mm	Minimum chamfer dimension
$r_{1 min}$	0,3 mm	Minimum chamfer dimension
d_s	4,8 mm	Diameter lubrication hole
n_s	9,5 mm	Width of lubricating groove

Mounting dimensions

d_a	110,5 mm	Diameter shaft shoulder
d_a	h12	Diameter shaft shoulder clearance
D_a	130,5 mm	Shoulder diameter outer ring
D_a	H12	Shoulder diameter outer ring clearance
$r_{a\ max}$	1,5 mm	Maximum recess radius
$r_{a1\ max}$	0,3 mm	Maximum recess radius
α	60 °	Contact angle
a	232,5 mm	Distance between the apexes of the pressure cones

Additional information

c_a	708 N/ μ m	Axial rigidity
K_{aE}	1.326 N	Lift-off force
F_v	465 N	Preload force