

FAG

★ QJ215-XL-MPA

Four-point contact bearing

Schaeffler ID:
0192608490000Four point contact bearing QJ2..-XL-MPA,
X-life, solid brass cage

★ Preferred product

X-life

Technical information

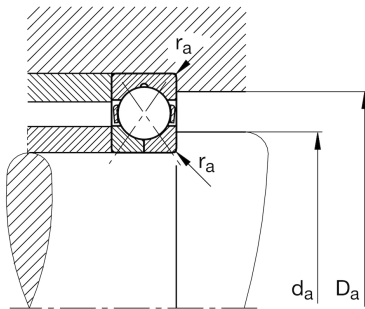
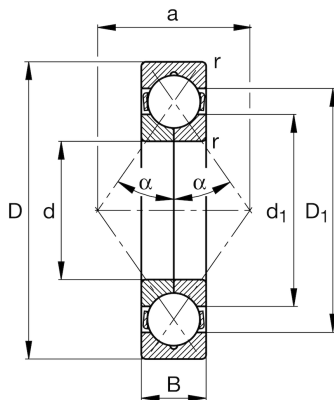

Temperature range

T_{min}	-30 °C	Operating temperature min.
T_{max}	150 °C	Operating temperature max.
	1,457 kg	Weight

Main Dimensions & Performance Data

d	75 mm	Bore diameter
D	130 mm	Outside diameter
B	25 mm	Width
C_r	123.000 N	Basic dynamic load rating, radial
C_{0r}	122.000 N	Basic static load rating, radial
C_{ur}	8.800 N	Fatigue load limit, radial
n_G	10.200 1/min	Limiting speed
n_{gr}	4.550 1/min	Reference speed

Dimensions

r_{min}	1,5 mm	Minimum chamfer dimension
D_1	111,5 mm	Shoulder diameter outer ring
d_1	93,9 mm	Shoulder diameter inner ring
a	72 mm	Distance between the apexes of the pressure cones
α	35 °	Contact angle

Mounting dimensions

$d_{a min}$	84 mm	Minimum diameter shaft shoulder
$D_{a max}$	121 mm	Maximum diameter of housing shoulder
$r_{a max}$	1,5 mm	Maximum fillet radius