

FAG

32030-X-XL

Tapered roller bearing

Schaeffler ID:
0832103260000Tapered roller bearings 320, main
dimensions to DIN ISO 355 / DIN 720,
separable, adjusted or in pairs

X-life

Technical information

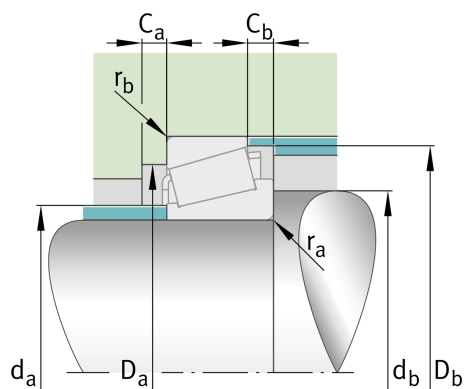
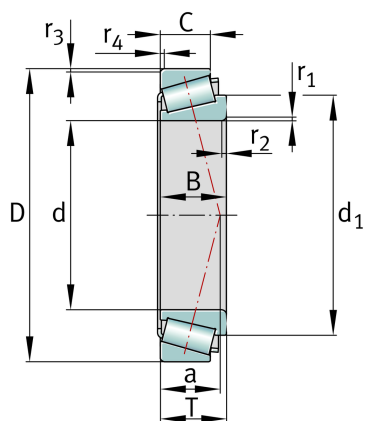

Main Dimensions & Performance Data

d	150 mm	Bore diameter
D	225 mm	Outside diameter
B	48 mm	Width, inner ring
C	36 mm	Width, outer ring
T	48 mm	Width, total
C_r	455.000 N	Basic dynamic load rating, radial
C_{0r}	680.000 N	Basic static load rating, radial
C_{ur}	96.000 N	Fatigue load limit, radial
n_G	3.200 1/min	Limiting speed
n_{gr}	1.990 1/min	Thermal speed rating
	6,461 kg	Weight

Dimensions

	T4EC150	Comparative designation to ISO 10317 and ISO 355
$r_{1,2 \text{ min}}$	3 mm	Minimum chamfer dimension of inner ring back face
$r_{3,4 \text{ min}}$	2,5 mm	Minimum chamfer dimension of outer ring back face
a	50 mm	Distance between the apexes of the pressure cones
d_1	187,8 mm	Guidance rib diameter of inner ring

Mounting dimensions

$d_{a \max}$	164 mm	Maximum diameter of shaft shoulder
$d_{b \min}$	162 mm	Minimum diameter of shaft shoulder
$D_{a \min}$	200 mm	Minimum diameter of housing shoulder
$D_{a \max}$	213 mm	Maximum diameter of housing shoulder
$D_{b \min}$	216 mm	Minimum diameter of housing shoulder
$C_{a \min}$	8 mm	Minimum axial space
$C_{b \min}$	12 mm	Minimum axial space
$r_{a \max}$	3 mm	Maximum fillet radius of shaft
$r_{b \max}$	2,5 mm	Maximum fillet radius of housing

Calculation factors

e	0,46	Limiting value of F_a/F_r for the applicability of diff. Values of factors X and Y
Y	1,31	Dynamic axial load factor
Y_0	0,72	Static axial load factor

Temperature range

T_{\min}	-30 °C	Operating temperature min.
T_{\max}	200 °C	Operating temperature max.