

## ★ NA6911-ZW-XL

Needle roller bearing

Schaeffler ID:  
0507442320000

Needle roller bearings NA69...ZW,  
Dimension series 69, double row

★ Preferred product

X-life

### Technical information

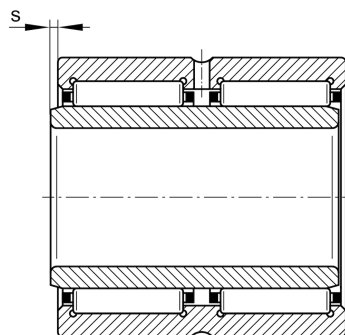
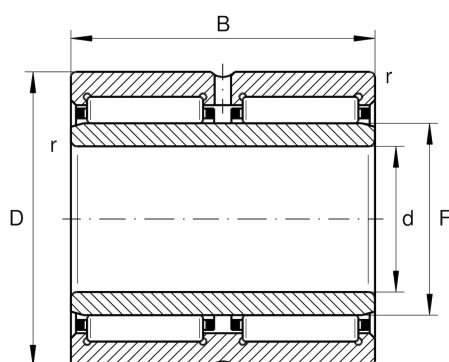

#### Temperature range

$T_{\min}$	-30 °C	Operating temperature min.
$T_{\max}$	120 °C	Operating temperature max.
	0,007 kg	Weight

#### Main Dimensions & Performance Data

d	55 mm	Bore diameter
D	80 mm	Outside diameter
B	45 mm	Width
$C_r$	102.000 N	Basic dynamic load rating, radial
$C_{0r}$	176.000 N	Basic static load rating, radial
$C_{ur}$	30.500 N	Fatigue load limit, radial
$n_G$	7.200 1/min	Limiting speed
$n_{gr}$	4.000 1/min	Reference speed

#### Dimensions

F	63 mm	Raceway diameter inner ring
$r_{\min}$	1 mm	Minimum chamfer dimension
s	1,5 mm	Axial displacement