

NAO30X47X16-XL

Needle roller bearing

Schaeffler ID:
0507781020000

Needle roller bearings NAO, without ribs

X-life

Technical information

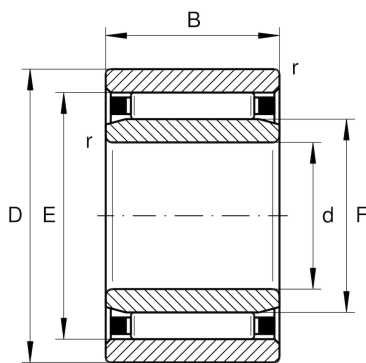

Main Dimensions & Performance Data

d	30 mm	Bore diameter
D	47 mm	Outside diameter
B	16 mm	Width
C_r	27.500 N	Basic dynamic load rating, radial
C_{0r}	37.500 N	Basic static load rating, radial
C_{ur}	6.300 N	Fatigue load limit, radial
n_G	12.700 1/min	Limiting speed
n_{gr}	6.900 1/min	Reference speed
	0,109 kg	Weight

Dimensions

F	35 mm	Raceway diameter inner ring
E	42 mm	Raceway diameter outer ring
r_{min}	0,3 mm	Minimum chamfer dimension
s	0,8 mm	Axial displacement

Mounting dimensions

d_a	34,5 mm	Mounting dimension
D_b	35,6 mm	Shoulder diameter axial guidance NK/housing
d_b	41,4 mm	Shoulder diameter axial guidance NK/shaft
D_a	42,5 mm	Shoulder diameter outer ring
$r_{a max}$	0,3 mm	Maximum recess radius

Temperature range

T_{min}	-30 °C	Operating temperature min.
T_{max}	120 °C	Operating temperature max.

