

NAO80X110X30-XL

Needle roller bearing

Schaeffler ID:
0507781700000

Needle roller bearings NAO, without ribs

X-life

Technical information

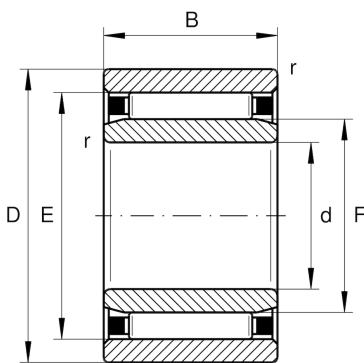

Main Dimensions & Performance Data

d	80 mm	Bore diameter
D	110 mm	Outside diameter
B	30 mm	Width
C_r	76.000 N	Basic dynamic load rating, radial
C_{0r}	172.000 N	Basic static load rating, radial
C_{ur}	30.000 N	Fatigue load limit, radial
n_G	5.200 1/min	Limiting speed
n_{gr}	3.200 1/min	Reference speed
	0,92 kg	Weight

Dimensions

F	90 mm	Raceway diameter inner ring
E	98 mm	Raceway diameter outer ring
r_{min}	1 mm	Minimum chamfer dimension
s	1 mm	Axial displacement

Mounting dimensions

d_a	89,3 mm	Mounting dimension
D_b	91 mm	Shoulder diameter axial guidance NK/housing
d_b	97,2 mm	Shoulder diameter axial guidance NK/shaft
D_a	99 mm	Shoulder diameter outer ring
$r_{a max}$	1 mm	Maximum recess radius

Temperature range

T_{min}	-30 °C	Operating temperature min.
T_{max}	120 °C	Operating temperature max.

