



★ NKI10/16-XL

Needle roller bearing

Schaeffler ID:
0507617140000

Needle roller bearings NKI, light series

★ Preferred product

X-life

Technical information

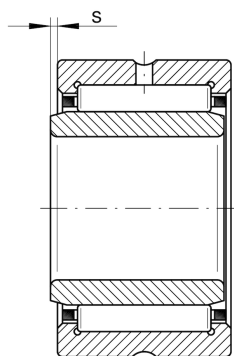
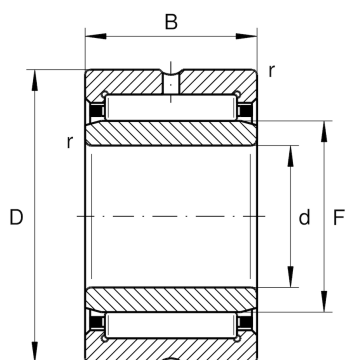

Temperature range

T_{\min}	-30 °C	Operating temperature min.
T_{\max}	120 °C	Operating temperature max.
	29,7 g	Weight

Main Dimensions & Performance Data

d	10 mm	Bore diameter
D	22 mm	Outside diameter
B	16 mm	Width
C_r	11.400 N	Basic dynamic load rating, radial
C_{0r}	11.500 N	Basic static load rating, radial
C_{ur}	2.140 N	Fatigue load limit, radial
n_G	24.600 1/min	Limiting speed
n_{gr}	16.400 1/min	Reference speed

Dimensions

F	14 mm	Raceway diameter inner ring
r_{\min}	0,3 mm	Minimum chamfer dimension
s	0,5 mm	Axial displacement