

★ NKI65/25-XL

Needle roller bearing

Schaeffler ID:
0507625080000

Needle roller bearings NKI, light series

★ Preferred product

X-life

Technical information

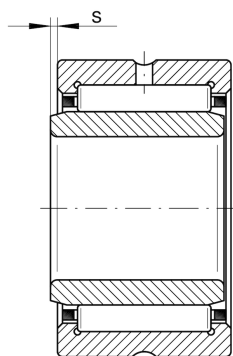
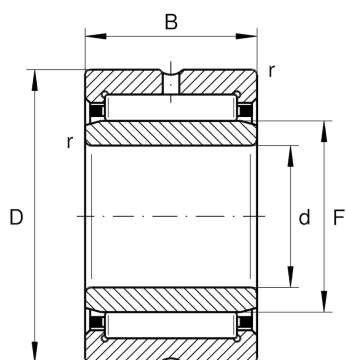

Temperature range

T_{\min}	-30 °C	Operating temperature min.
T_{\max}	120 °C	Operating temperature max.
	0,467 kg	Weight

Main Dimensions & Performance Data

d	65 mm	Bore diameter
D	90 mm	Outside diameter
B	25 mm	Width
C_r	60.000 N	Basic dynamic load rating, radial
C_{0r}	100.000 N	Basic static load rating, radial
C_{ur}	17.900 N	Fatigue load limit, radial
n_G	6.300 1/min	Limiting speed
n_{gr}	3.900 1/min	Reference speed

Dimensions

F	73 mm	Raceway diameter inner ring
r_{\min}	1 mm	Minimum chamfer dimension
s	1 mm	Axial displacement