

**NKIS50-XL**

Radial roller bearing

Schaeffler ID:
0507712480000

Needle roller bearings NKIS, heavy series

X-life

Technical information

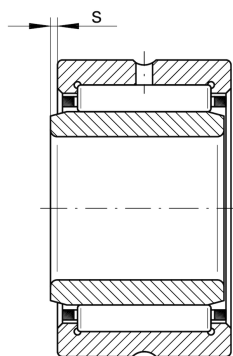
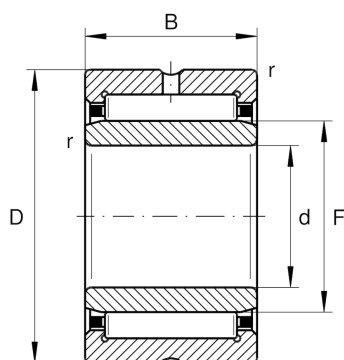
**Main Dimensions & Performance Data**

d	50 mm	Bore diameter
D	80 mm	Outside diameter
B	28 mm	Width
C_r	71.000 N	Basic dynamic load rating, radial
C_{0r}	98.000 N	Basic static load rating, radial
C_{ur}	17.600 N	Fatigue load limit, radial
n_G	7.400 1/min	Limiting speed
$n_{G \text{ Grease}}$	4.400 1/min	Limiting speed for grease lubrication
n_{gr}	4.250 1/min	Reference speed
	0,526 kg	Weight

Dimensions

r_{\min}	1,1 mm	Minimum chamfer dimension
F	60 mm	Raceway diameter inner ring
s	2 mm	Axial displacement

Temperature range

T_{\min}	-30 °C	Operating temperature min.
T_{\max}	120 °C	Operating temperature max.