

★ NKX70-XL

Needle roller/axial ball bearing

Schaeffler ID:
0506053050000

Needle roller/axial ball bearings NKX, axial component, single direction, to DIN 5429, without end cap, for oil lubrication

★ Preferred product

X-life

Technical information

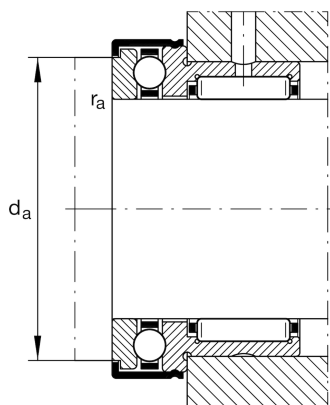
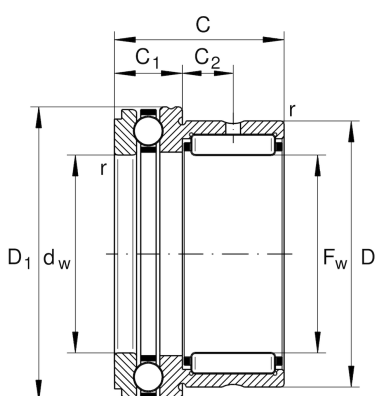

Temperature range

T_{min}	-30 °C	Operating temperature min.
T_{max}	120 °C	Operating temperature max.
	0,006 kg	Weight

Main Dimensions & Performance Data

F_w	70 mm	Bore diameter
D	85 mm	Outside diameter
C	40 mm	Height
C_r	50.000 N	Basic dynamic load rating, radial
C_{0r}	92.000 N	Basic static load rating, radial
C_a	43.000 N	Basic dynamic load rating, axial
C_{0a}	127.000 N	Basic static load rating, axial
C_{ur}	16.000 N	Fatigue load limit, radial
C_{ua}	6.300 N	Fatigue load limit, axial
n_G	2.400 1/min	Limiting speed

Dimensions

D_{1max}	95,2 mm	Maximum outside diameter flange
D_{2max}	95,2 mm	Maximum outside diameter flange
C_1	18 mm	Width of the axial bearing component
C_1	11 mm	Distance to lubrication hole
C_2	11 mm	Distance to lubrication hole
d_w	70 mm	Bore diameter of shaft washer
r_{min}	1 mm	Minimum chamfer dimension

Mounting dimensions

d_a	90,5 mm	Mounting dimension shaft shoulder
$r_{a max}$	1 mm	Maximum recess radius

Additional information

IR60X70X25-XL

Suitable inner rings IR