

★ NKX40-Z-XL

Needle roller/axial ball bearing

Schaeffler ID:
0507476140000

Needle roller/axial ball bearings NKX...-Z, axial component, single direction, to DIN 5429, with end cap, for grease lubrication

★ Preferred product

X-life

Technical information

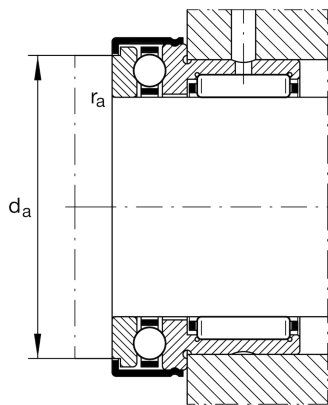
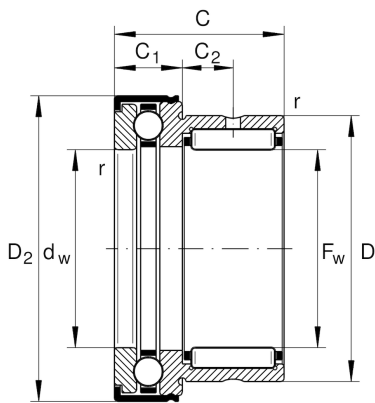

Temperature range

T_{min}	-30 °C	Operating temperature min.
T_{max}	120 °C	Operating temperature max.
	0,002 kg	Weight

Main Dimensions & Performance Data

F_w	40 mm	Bore diameter
D	52 mm	Outside diameter
C	32 mm	Height
C_r	29.500 N	Basic dynamic load rating, radial
C_{0r}	47.000 N	Basic static load rating, radial
C_a	27.000 N	Basic dynamic load rating, axial
C_{0a}	63.000 N	Basic static load rating, axial
C_{ur}	8.400 N	Fatigue load limit, radial
C_{ua}	3.100 N	Fatigue load limit, axial
n_G	4.000 1/min	Limiting speed

Dimensions

D_{1max}	61,2 mm	Maximum outside diameter flange
D_{2max}	61,2 mm	Maximum outside diameter flange
C_1	13 mm	Width of the axial bearing component
C_1	10 mm	Distance to lubrication hole
C_2	10 mm	Distance to lubrication hole
d_w	40 mm	Bore diameter of shaft washer
r_{min}	0,6 mm	Minimum chamfer dimension

Mounting dimensions

d_a	55,7 mm	Mounting dimension shaft shoulder
$r_{a max}$	0,6 mm	Maximum recess radius

Additional information

IR35X40X20-XL

Suitable inner rings IR