

★ 81114-TV

Axial cylindrical roller bearing

Schaeffler ID:
0007143990000

Axial cylindrical roller bearings 811, single direction, comprising K811, GS, WS

★ Preferred product

Technical information

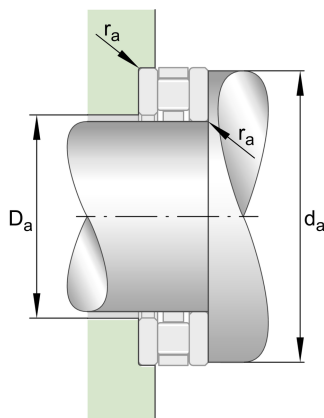
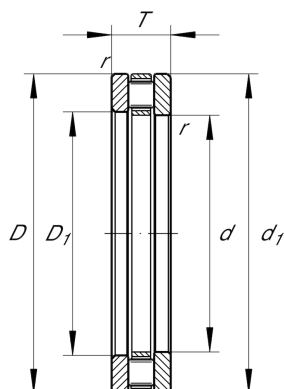

Temperature range

T_{\min}	120 °C	Operating temperature min.
T_{\max}	-30 °C	Operating temperature max.
	0,003 kg	Weight

Main Dimensions & Performance Data

d	70 mm	Bore diameter
D	95 mm	Outside diameter
T	18 mm	Height
C_a	111.000 N	Basic dynamic load rating, axial
C_{0a}	365.000 N	Basic static load rating, axial
C_{ua}	37.000 N	Fatigue load limit, axial
n_G	3.500 1/min	Limiting speed
n_{gr}	1.170 1/min	Reference speed

Dimensions

D_1	72 mm	Bore diameter housing washer
d_1	95 mm	Rip diameter shaft washer
r_{\min}	1 mm	Minimum chamfer dimension

Mounting dimensions

$d_{a \min}$	92 mm	Minimum diameter shaft shoulder
$D_{a \max}$	72 mm	Maximum diameter of housing shoulder
$r_{a \max}$	1 mm	Maximum recess radius

Additional information

K81114-TV	Axial roller and cage assembly
GS81114	Housing Washer
WS81114	Shaft washer
LS7095	Track Washer