

## ★ NKXR45-Z-XL

Needle roller/axial cylindrical roller bearing

Schaeffler ID:  
0507918340000

★ Preferred product

Needle roller/axial cylindrical roller bearings NKXR...-Z, axial component, single direction, to DIN 5429, with end cap, for grease lubrication

X-life

### Technical information

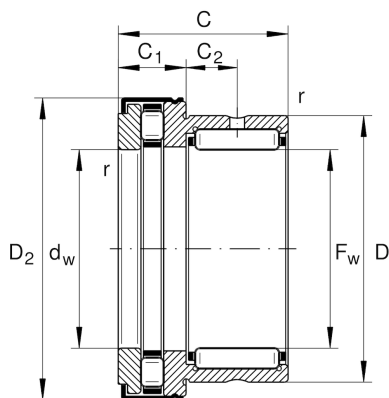
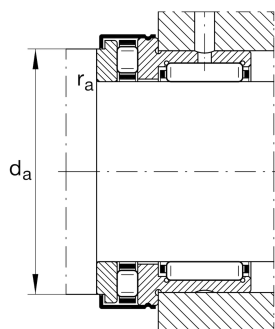

#### Temperature range

$T_{min}$	-30 °C	Operating temperature min.
$T_{max}$	120 °C	Operating temperature max.
	0,003 kg	Weight

#### Main Dimensions & Performance Data

$F_w$	45 mm	Bore diameter
$D$	58 mm	Outside diameter
$C$	32 mm	Height
$C_r$	31.000 N	Basic dynamic load rating, radial
$C_{0r}$	53.000 N	Basic static load rating, radial
$C_a$	59.000 N	Basic dynamic load rating, axial
$C_{0a}$	163.000 N	Basic static load rating, axial
$C_{ur}$	9.400 N	Fatigue load limit, radial
$C_{ua}$	16.300 N	Fatigue load limit, axial
$n_G$	5.000 1/min	Limiting speed
$n_{gr}$	1.900 1/min	Reference speed

#### Dimensions

$D_{1max}$	66,5 mm	Maximum outside diameter flange
$D_{2max}$	66,5 mm	Maximum outside diameter flange
$C_1$	14 mm	Width of the axial bearing component
$C_2$	9 mm	Distance to lubrication hole
$d_w$	45 mm	Bore diameter of shaft washer
$r_{min}$	0,6 mm	Minimum chamfer dimension

#### Mounting dimensions

$d_a$	60,6 mm	Mounting dimension shaft shoulder
$r_{a max}$	0,6 mm	Maximum recess radius

**Additional information**

---

IR40X45X20-XL

Suitable inner rings IR