



PCJT12-XL

Flanged housing unit

Schaeffler ID:
0008533990000

Housing units PCJT, two-bolt flanged housing units, cast iron, eccentric locking collar, P seals

X-life

Technical information

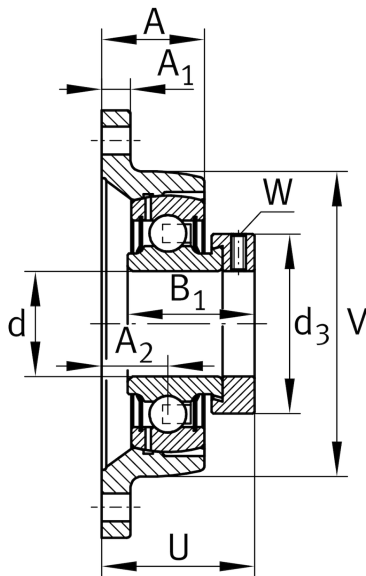
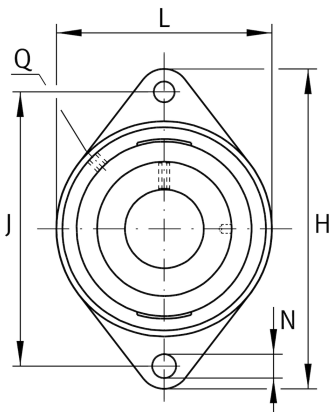

Main Dimensions & Performance Data

d	12 mm	Bore diameter
L	57 mm	Flange width
H	99 mm	Height flange
U	39,1 mm	Total height unit
C_r	9.800 N	Basic dynamic load rating, radial
C_{0r}	4.750 N	Basic static load rating, radial
C_{ur}	248 N	Fatigue load limit, radial
	0,4 kg	Weight

Dimensions

A	25 mm	Height housing
	1	Number of housings
A_1	9,5 mm	Thickness of flange
A_2	17 mm	Distance raceway
	CJT03	Housing
	GRAE12-XL-NPP-B	Bearing designation
V	57 mm	Shoulder diameter housing
Q	M6	Connection thread lubrication
d_3	28,4 mm	Outside diameter eccentric locking collar

Mounting dimensions

J	76,5 mm	Distance fixing bore
N	11.5 mm	Fixing bore
n	2	Number of screwing holes