



## PCJY12-XL

### Flanged housing unit

Schaeffler ID:  
0009491910000

Housing units PCJY, four-bolt flanged housing units, cast iron, grub screws in inner ring, P seals

X-life

## Technical information

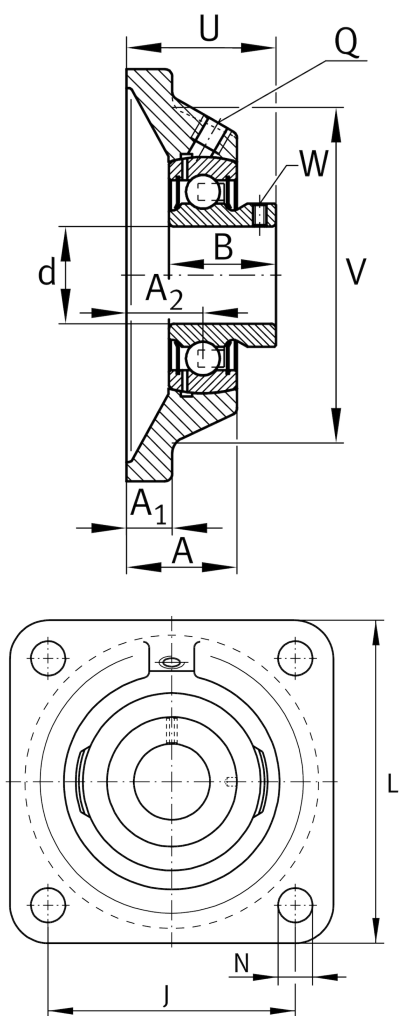

### Main Dimensions & Performance Data

d	12 mm	Bore diameter
L	76 mm	Flange width
U	33 mm	Total height unit
$C_r$	10.100 N	Basic dynamic load rating, radial
$C_{0r}$	4.750 N	Basic static load rating, radial
$C_{ur}$	202 N	Fatigue load limit, radial
	0,44 kg	Weight

### Dimensions

A	27 mm	Height housing
	1	Number of housings
$A_1$	9,5 mm	Thickness of flange
$A_2$	17 mm	Distance raceway
	CJ03	Housing
	GAY12-XL-NPP-B	Bearing designation
B	22 mm	Width
V	58 mm	Shoulder diameter housing
Q	M6	Connection thread lubrication

### Mounting dimensions

J	54 mm	Distance fixing bore
N	11.5 mm	Fixing bore
n	4	Number of screwing holes