



PBY15-XL

Plummer block housing unit

Schaeffler ID:
0009028290000

Plummer block housing unit PBY..-XL,
RIBB sheet metal PB

X-life

Technical information

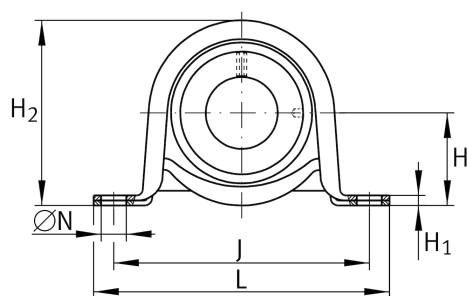
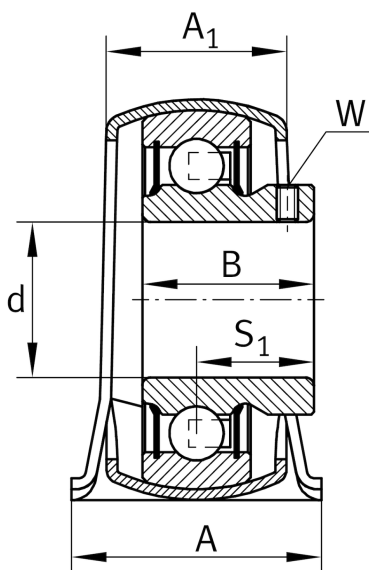

Main Dimensions & Performance Data

d	15 mm	Bore diameter
L	85,7 mm	Length total
H ₂	43,2 mm	Height
C _{0rG}	1.350 N	Load carrying capacity (housing)
C _r	10.100 N	Basic dynamic load rating, radial
C _{0r}	4.750 N	Basic static load rating, radial
n _{G Grease}	22.300 1/min	Limiting speed for grease lubrication
	0,15 kg	Weight

Dimensions

H	22,2 mm	Distance shaft axis
	GEH40-BT	Housing
A	25,4 mm	Width (base)
	AY15-XL-NPP-B	Bearing designation
A ₁	18,4 mm	Width (head)
H ₁	2,6 mm	Height (base)

Mounting dimensions

J	68 mm	Distance fixing bore
N	9.5 mm	Fixing bore

Calculation factors

f ₀	13	Calculation factor
----------------	----	--------------------