

PSHEY17-XL

Plummer block housing unit

Schaeffler ID:
0009257130000

Plummer block housing units PSHEY, cast iron housing, radial insert ball bearing with grub screws in inner ring, P seals

X-life

Technical information

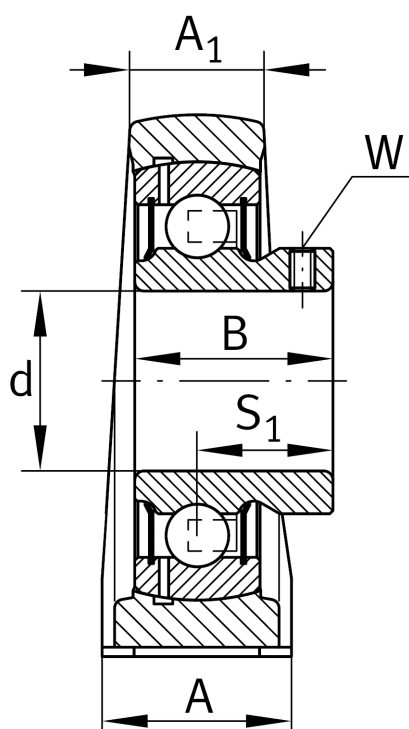
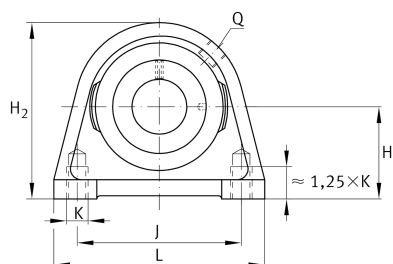

Main Dimensions & Performance Data

d	17 mm	Bore diameter
L	63 mm	Length total
H ₂	57 mm	Height
	0,35 kg	Weight

Dimensions

H	30,2 mm	Distance shaft axis
	SHE03	Housing
	GAY17-XL-NPP-B	Bearing designation
A	30 mm	Width (base)
A ₁	18 mm	Width (head)
Q	M6	Connection thread lubrication

Mounting dimensions

J	47 mm	Distance fixing bore
K	M8	Thread fixing bore