

RSHEY17-XL

Plummer block housing unit

Schaeffler ID:
0009852790000

Plummer block housing units RSHEY, cast iron housing, radial insert ball bearing with grub screws in inner ring, R seals

X-life

Technical information

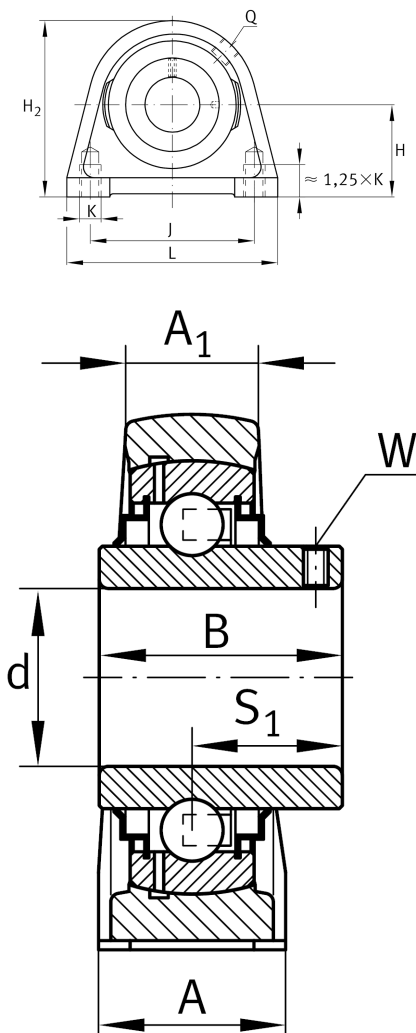

Main Dimensions & Performance Data

d	17 mm	Bore diameter
L	63 mm	Length total
H ₂	57 mm	Height
	0,63 kg	Weight

Dimensions

H	30,2 mm	Distance shaft axis
	SHE03	Housing
	GYE17-XL-KRR-B	Bearing designation
A	30 mm	Width (base)
A ₁	18 mm	Width (head)
Q	M6	Connection thread lubrication

Mounting dimensions

J	47 mm	Distance fixing bore
K	M8	Thread fixing bore