

## RSHEY30-XL-N

Plummer block housing unit

Schaeffler ID:  
0008645790000

Plummer block housing units RSHEY, cast iron housing, radial insert ball bearing with grub screws in inner ring, R seals

X-life

### Technical information

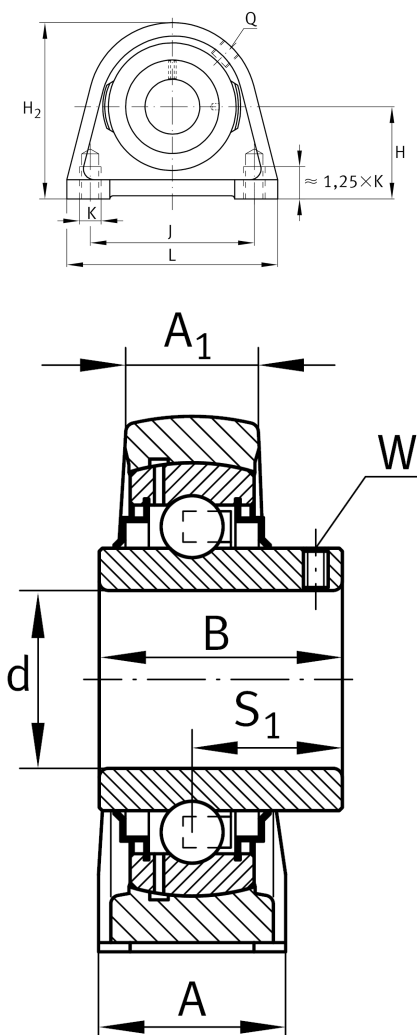

#### Main Dimensions & Performance Data

d	30 mm	Bore diameter
L	98 mm	Length total
H <sub>2</sub>	82 mm	Height
	0,94 kg	Weight

#### Dimensions

H	42,9 mm	Distance shaft axis
A	40 mm	Width (base)
A <sub>1</sub>	25 mm	Width (head)
Q	Rp1/8	Connection thread lubrication

#### Mounting dimensions

J	76,2 mm	Distance fixing bore
K	M10	Thread fixing bore

#### Additional information

SHE06	Housing
GYE30-XL-KRR-B	Bearing designation
KASK06	Protecting cap