

## TASE35-XL-N

Plummer block housing unit

Schaeffler ID:  
0008567620000

Plummer block housing units TASE, cast iron housing, radial insert ball bearing with eccentric locking collar, T seals

X-life

### Technical information

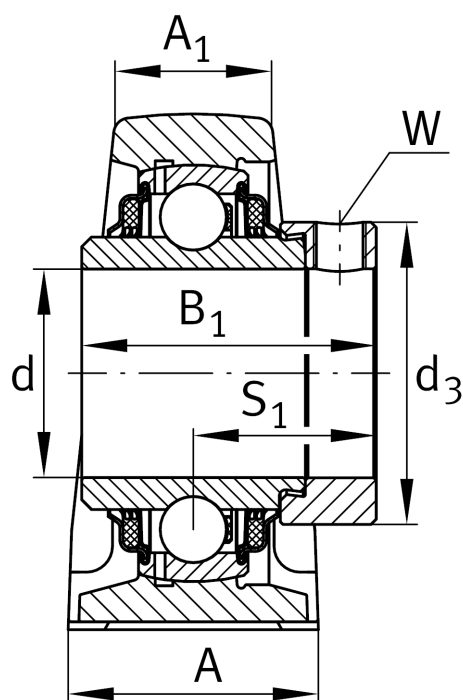
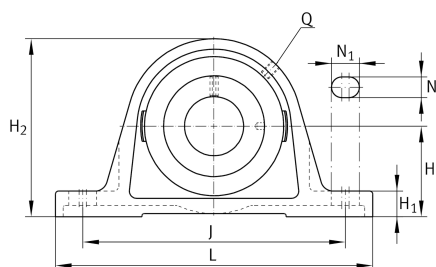

### Main Dimensions & Performance Data

d	35 mm	Bore diameter
L	163 mm	Length total
H <sub>2</sub>	93 mm	Height
	1,65 kg	Weight

### Dimensions

H	47,6 mm	Distance shaft axis
	ASE07	Housing
	GE35-XL-KTT-B	Bearing designation
A	45 mm	Width (base)
	KASK07	Protecting cap
A <sub>1</sub>	27 mm	Width (head)
H <sub>1</sub>	19 mm	Height (base)
B <sub>1</sub>	51,3 mm	Locking collar total width
S <sub>1</sub>	32,5 mm	Distance of raceway to locking collar
Q	M6	Connection thread lubrication

### Mounting dimensions

J	126 mm	Distance fixing bore
N	14 mm	Width (slot)
N <sub>1</sub>	21 mm	Length (slot)