



PHEY40-XL

Take-up housing unit

Schaeffler ID:
0009493020000

Take-up housing units PHEY, cast iron housing, radial insert ball bearing with grub screws in inner ring, P seals

X-life

Technical information

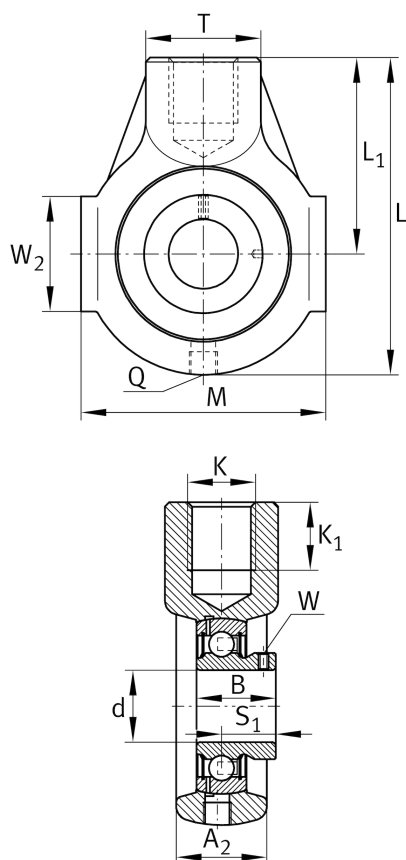

Main Dimensions & Performance Data

d	40 mm	Bore diameter
L	135 mm	Length total
M	100 mm	Housing total width
A ₂	36 mm	Width housing
	1,5 kg	Weight

Dimensions

L ₁	85 mm	Distance shaft axis
	HE08	Housing
	GAY40-XL-NPP-B	Bearing designation
T	40 mm	Height housing fixing side
W	45 mm	Length of guidance face
Q	M6	Connection thread lubrication

Mounting dimensions

K	M24	Thread fixing bore
K ₁	24 mm	Thread depth