



FAG

N1019-D-K-TVP-SP-XL

Cylindrical roller bearing

Schaeffler ID:
0876553730000Super precision cylindrical roller bearings
N10..-D-K-TVP-SP, non-locating bearing,
with tapered bore, taper 1:12, separable,
with cage

X-life

Technical information

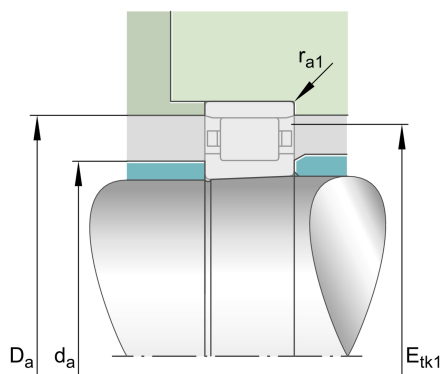
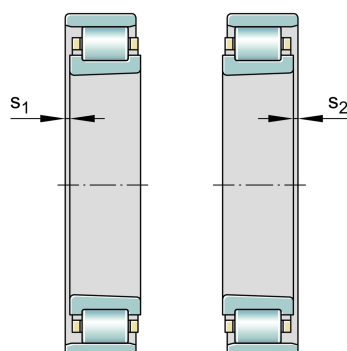
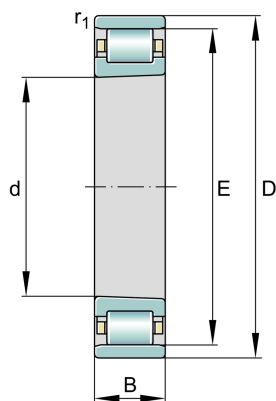
**Main Dimensions & Performance Data**

d	95 mm	Bore diameter
D	145 mm	Outside diameter
B	24 mm	Width
C_r	99.000 N	Basic dynamic load rating, radial
C_{0r}	117.000 N	Basic static load rating, radial
C_{ur}	18.000 N	Fatigue load limit, radial
$n_{G \text{ Grease}}$	7.700 1/min	Limiting speed for grease lubrication
$n_{G \text{ Oil}}$	9.100 1/min	Limiting speed for oil lubrication
	1,255 kg	Weight

Additional information

$r_{1 \text{ min}}$	1,1 mm	Minimum chamfer dimension
s_1	4,4 mm	Axial displacement
s_2	4,4 mm	Axial displacement
E	132 mm	Raceway diameter outer ring

Mounting dimensions

$d_{a \text{ min}}$	110 mm	Minimum diameter shaft shoulder
$D_{a \text{ max}}$	133,5 mm	Maximum diameter of housing shoulder
$E_{tk1 \text{ nom}}$	129,8 mm	Injection pitch diameter min
$r_{a1 \text{ max}}$	1 mm	Maximum recess radius

Temperature range

T_{min}	-30 °C	Operating temperature min.
T_{max}	120 °C	Operating temperature max.