

FAG

23160-BEA-XL-MB1

Spherical roller bearing

Schaeffler ID:
0683529800000Spherical roller bearing 231..-BEA-XL-
MB1, symmetric 2 outer ribs with rib
washer

X-life

Technical information

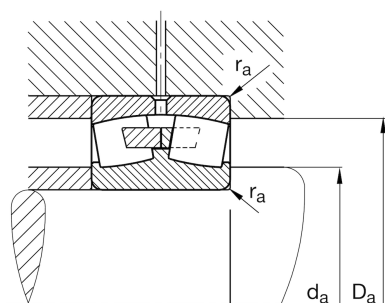
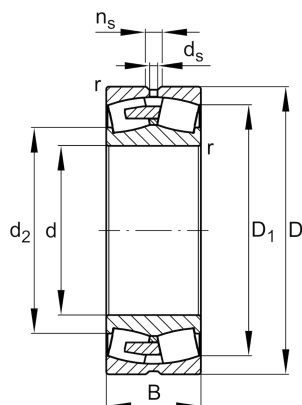
**Main Dimensions & Performance Data**

d	300 mm	Bore diameter
D	500 mm	Outside diameter
B	160 mm	Width
C_r	3.250.000 N	Basic dynamic load rating, radial
C_{0r}	4.950.000 N	Basic static load rating, radial
C_{ur}	375.000 N	Fatigue load limit, radial
n_G	1.300 1/min	Limiting speed
n_{gr}	720 1/min	Reference speed
	124,915 kg	Weight

Additional information

r_{min}	5 mm	Minimum chamfer dimension
D_1	436,8 mm	Bore diameter outer ring
d_s	9,5 mm	Diameter lubrication hole
n_s	17,7 mm	Width of lubricating groove

Mounting dimensions

$d_{a min}$	320 mm	Minimum diameter shaft shoulder
$D_{a max}$	480 mm	Maximum diameter of housing shoulder
$r_{a max}$	4 mm	Maximum recess radius

Calculation factors

e	0,31	Limiting value of F_a/F_r for the applicability of diff. Values of factors X and Y
Y_1	2,18	Dynamic axial load factor
Y_2	3,24	Dynamic axial load factor
Y_0	2,13	Static axial load factor

Temperature range

T _{min}	-30 °C	Operating temperature min.
T _{max}	200 °C	Operating temperature max.