



FAG

**SNS3134-H-D**

Plummer block housing

Schaeffler ID:  
0806123930000

Plummer block housing, split, for spherical roller bearings, metric and inch size shaft diameters, for grease lubrication

## Technical information

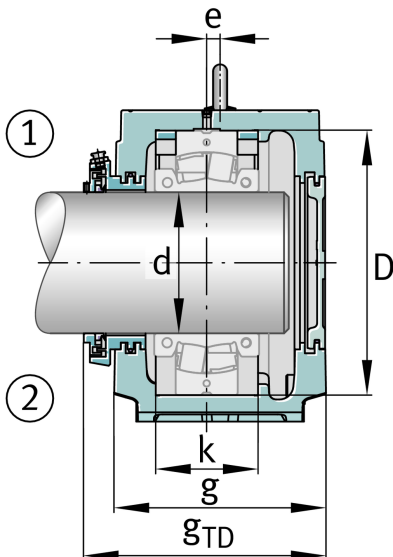
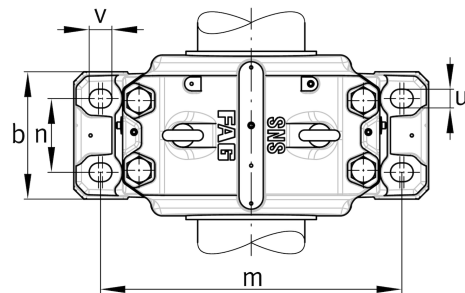
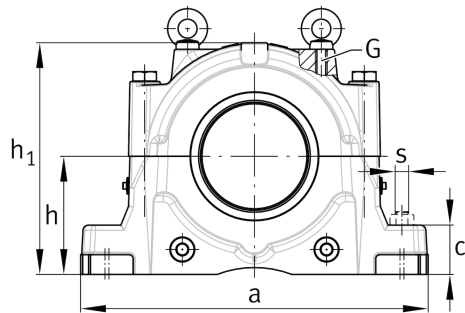
**Main Dimensions & Performance Data**

$h_1$	333 mm	Housing height
$g$	230 mm	Housing width
$a$	510 mm	length base
	74,9 kg	Weight

**Dimensions**

$c$	70 mm	Base height
$b$	180 mm	Base width
$n_2$	100 mm	Base hole distance 2
$D$	280 mm	Bearing seat
$e$	14 mm	Center offset
$h$	170 mm	Center height
$k$	108 mm	Bearing seat width
$m$	430 mm	Base hole distance 1
$s$	M24	Screw size base hole fixing
$u$	28 mm	Base hole width
$v$	34 mm	Base hole length

