



FAG

SNS3144-H-D

Plummer block housing

Schaeffler ID:
0806130710000

Plummer block housing, split, for spherical roller bearings, metric and inch size shaft diameters, for grease lubrication

Technical information

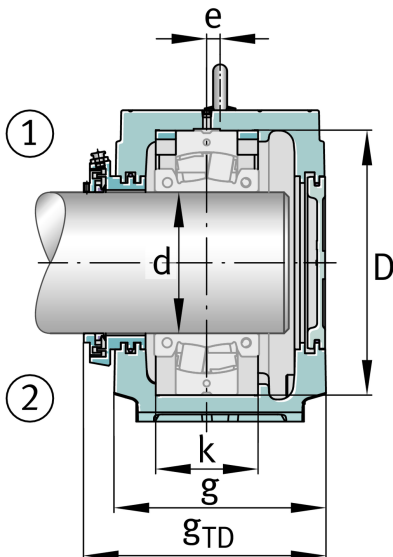
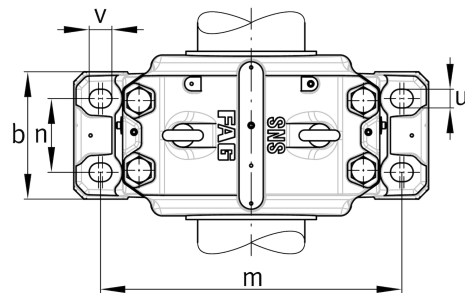
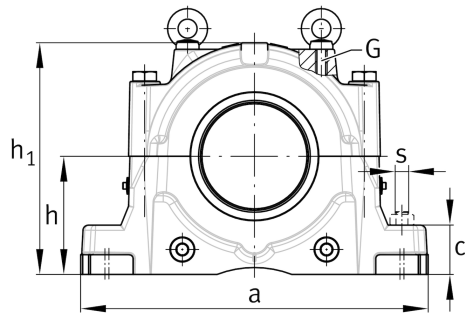
**Main Dimensions & Performance Data**

h_1	434 mm	Housing height
g	290 mm	Housing width
a	640 mm	length base
	145,8 kg	Weight

Dimensions

c	90 mm	Base height
b	240 mm	Base width
n_2	140 mm	Base hole distance 2
D	370 mm	Bearing seat
e	12 mm	Center offset
h	220 mm	Center height
k	140 mm	Bearing seat width
m	540 mm	Base hole distance 1
s	M30	Screw size base hole fixing
u	35 mm	Base hole width
v	42 mm	Base hole length

