



FAG

SNS3134-Z-D

Plummer block housing

Schaeffler ID:
0806124230000

Plummer block housing, split, for spherical roller bearings with cylindrical bore, metric shaft diameters, for grease lubrication

Technical information

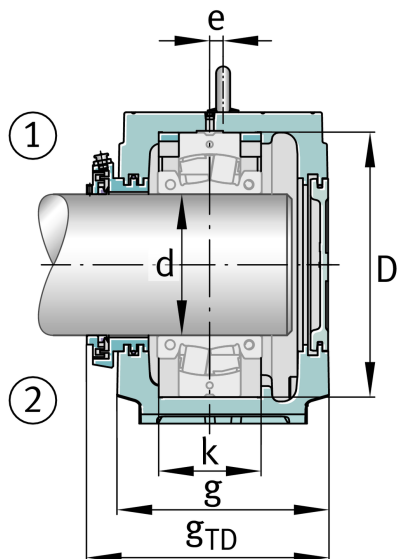
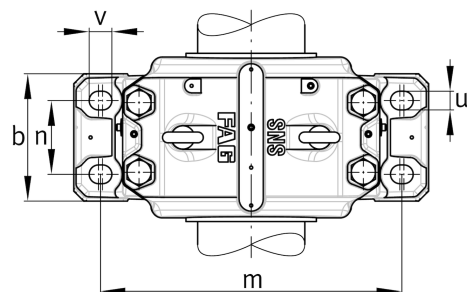
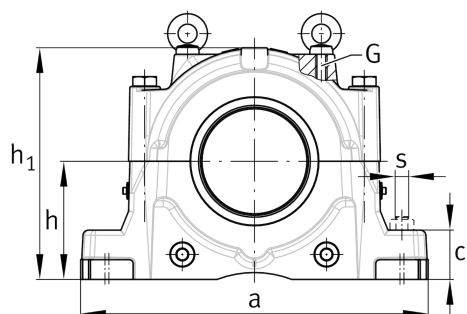
**Main Dimensions & Performance Data**

h_1	333 mm	Housing height
g	230 mm	Housing width
a	510 mm	length base
	70,2 kg	Weight

Dimensions

c	70 mm	Base height
b	180 mm	Base width
n_2	100 mm	Base hole distance 2
D	280 mm	Bearing seat
e	14 mm	Center offset
h	170 mm	Center height
k	108 mm	Bearing seat width
m	430 mm	Base hole distance 1
s	M24	Screw size base hole fixing
u	28 mm	Base hole width
v	34 mm	Base hole length

