



FAG

SNS3238-Z-D

Plummer block housing

Schaeffler ID:
0806337490000

Plummer block housing, split, for spherical roller bearings with cylindrical bore, metric shaft diameters, for grease lubrication

Technical information

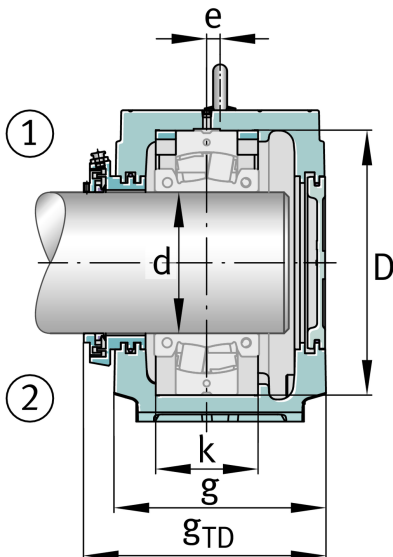
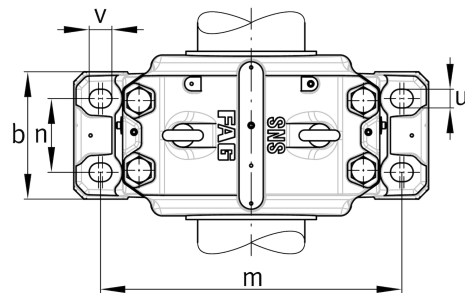
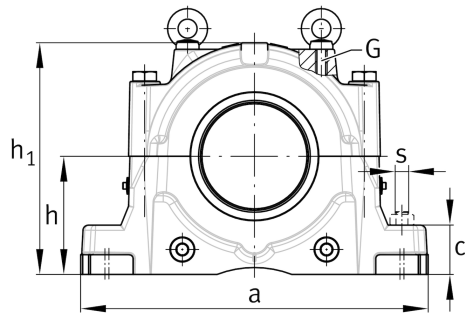
**Main Dimensions & Performance Data**

h_1	411 mm	Housing height
g	280 mm	Housing width
a	610 mm	length base
	125,1 kg	Weight

Dimensions

c	85 mm	Base height
b	230 mm	Base width
n_2	130 mm	Base hole distance 2
D	340 mm	Bearing seat
e	10 mm	Center offset
h	210 mm	Center height
k	132 mm	Bearing seat width
m	510 mm	Base hole distance 1
s	M30	Screw size base hole fixing
u	35 mm	Base hole width
v	43 mm	Base hole length

