



FAG

**SNS3244-Z-D**

Plummer block housing

Schaeffler ID:  
0806344780000

Plummer block housing, split, for spherical roller bearings with cylindrical bore, metric shaft diameters, for grease lubrication

## Technical information

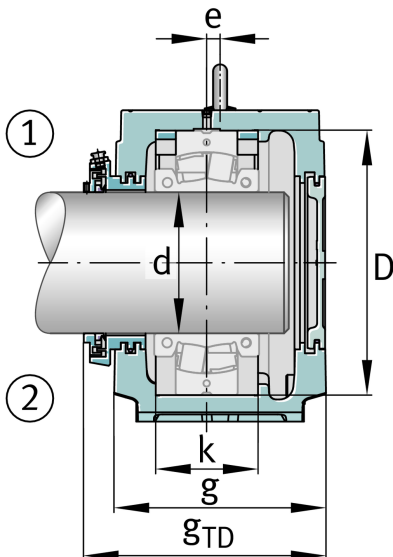
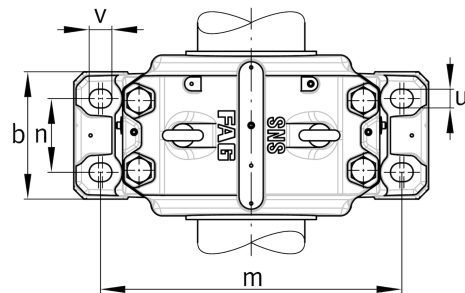
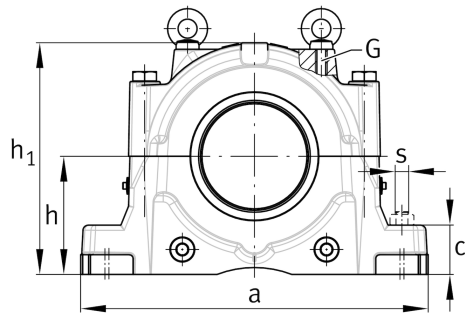
**Main Dimensions & Performance Data**

$h_1$	474 mm	Housing height
$g$	310 mm	Housing width
$a$	700 mm	length base
	173,9 kg	Weight

**Dimensions**

$c$	95 mm	Base height
$b$	260 mm	Base width
$n_2$	150 mm	Base hole distance 2
$D$	400 mm	Bearing seat
$e$	12 mm	Center offset
$h$	240 mm	Center height
$k$	164 mm	Bearing seat width
$m$	600 mm	Base hole distance 1
$s$	M30	Screw size base hole fixing
$u$	35 mm	Base hole width
$v$	42 mm	Base hole length

