



## ★ FLCTEY12-XL

Flanged housing unit

Schaeffler ID:  
0009256750000

★ Preferred product

Housing units FLCTEY, two-bolt flanged housing units, cast iron, grub screws in inner ring, P seals, without relubrication facility

X-life

### Technical information

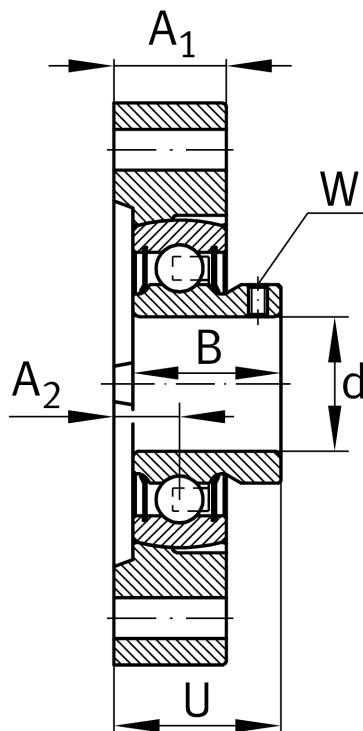
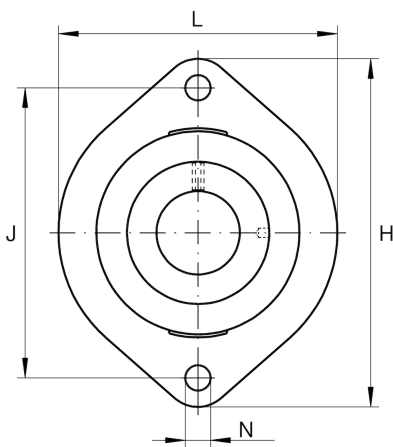

### Main Dimensions & Performance Data

d	12 mm	Bore diameter
L	58,7 mm	Flange width
H	81 mm	Height flange
U	24,4 mm	Total height unit
C <sub>r</sub>	9.800 N	Basic dynamic load rating, radial
C <sub>0r</sub>	4.750 N	Basic static load rating, radial
C <sub>ur</sub>	202 N	Fatigue load limit, radial
	0,28 kg	Weight

### Dimensions

A <sub>1</sub>	15 mm	Thickness of flange
A <sub>2</sub>	8,4 mm	Distance raceway
d <sub>3</sub>	28,4 mm	Outside diameter eccentric locking collar

### Mounting dimensions

J	63,5 mm	Distance fixing bore
J	63,5 mm	Pitch circle diameter (holes)
N	6.6 mm	Fixing bore
n	2	Number of screwing holes

### Additional information

	1	Number of housings
	LCTE03	Housing
	AY12-XL-NPP-B	Bearing designation