

KBO25-PP-AS

Linear ball bearing

Schaeffler ID:
0015219420000

Linear ball bearings KBO..-PP-AS, machined range, open design, sealed on all sides, with relubrication facility, corrosion-resistant design possible

Technical information

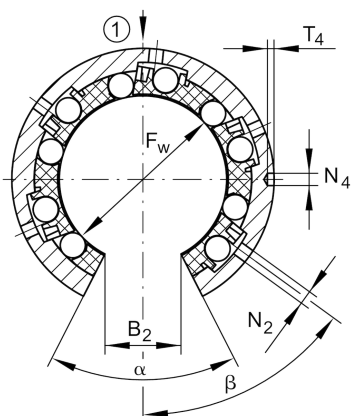
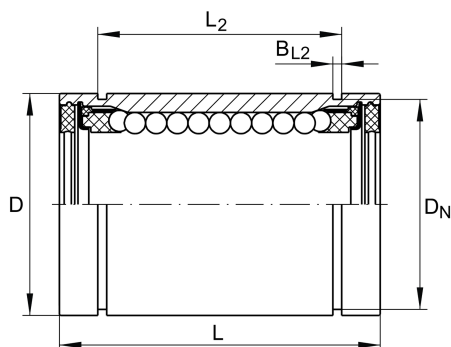

Main Dimensions & Performance Data

F_w	25 mm	Bore diameter of ball complement
D	40 mm	Outside diameter
L	58 mm	length
	h12	Tolerance
C_{max}	2.850 N	load capacity dyn.
C_{0max}	2.300 N	load capacity stat.
	0,157 kg	Weight

Mounting dimensions

B_2	12,5 mm	Width of sector opening
L_2	43,7 mm	
	H13	Tolerance
B_{L2}	1,85 mm	
D_N	37,5 mm	
T_4	1,5 mm	
N_4	3 mm	
N_2	2,5 mm	
α	60 °	Angle of sector opening
β	53 °	
	5	Number of rows balls