



★ RME100-XL

Flanged housing unit

Schaeffler ID:
0008776540000

★ Preferred product

Housing units RME, four-bolt flanged housing units, cast iron, centring spigot, eccentric locking collar, R seals

X-life

Technical information

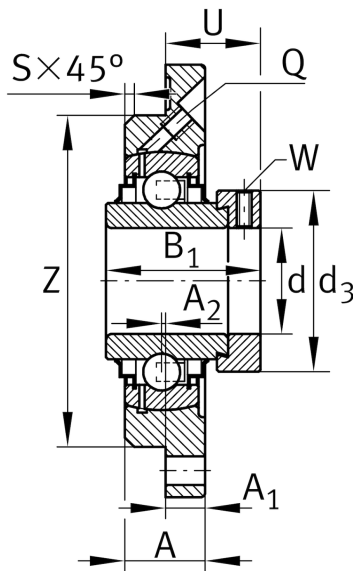
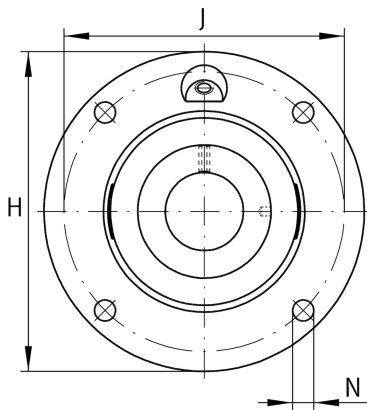

Main Dimensions & Performance Data

d	100 mm	Bore diameter
H	295 mm	Height flange
B ₁	75 mm	Locking collar total width
U	53,4 mm	Total height unit
C _r	130.000 N	Basic dynamic load rating, radial
C _{0r}	93.000 N	Basic static load rating, radial
C _{ur}	4.100 N	Fatigue load limit, radial
	11,58 kg	Weight

Dimensions

A	36 mm	Height housing
A ₁	22 mm	Thickness of flange
A ₂	-4 mm	Distance raceway
S	3 mm	Chamfer width
Q	M6	Connection thread lubrication

Mounting dimensions

J	245 mm	Pitch circle diameter (holes)
N	23 mm	Fixing bore
Z	210 mm	Diameter spigot
	h8	Diameter spigot clearance
n	4	Number of screwing holes

Additional information

	1	Number of housings
	GG.ME20	Housing
	GE100-XL-KRR-B	Bearing designation