

★ AS0515

Axial bearing washer

Schaeffler ID:
0007888210000

Axial bearing washers, suitable for AXK
and K811, to DIN 5405-3/ISO 303

★ Preferred product

Technical information

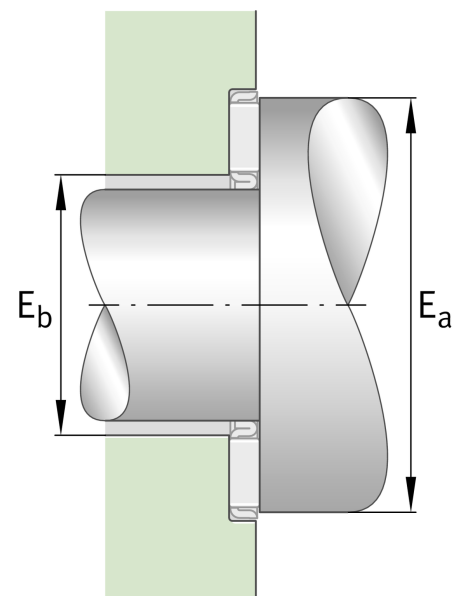
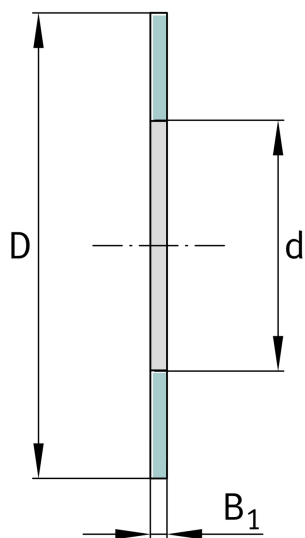

Main Dimensions & Performance Data

d	5 mm	Bore diameter bearing washer
D	15 mm	Outside diameter bearing washer
B ₁	1 mm	Height bearing washer
	1,2 g	Weight