

★ AS0619

Axial bearing washer

Schaeffler ID:
0007888480000

Axial bearing washers, suitable for AXK
and K811, to DIN 5405-3/ISO 303

★ Preferred product

Technical information

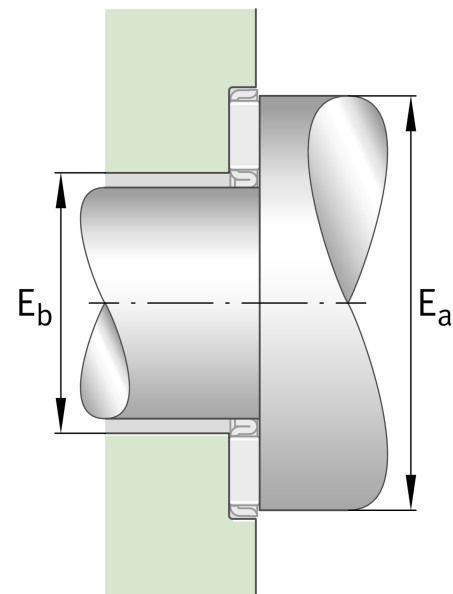
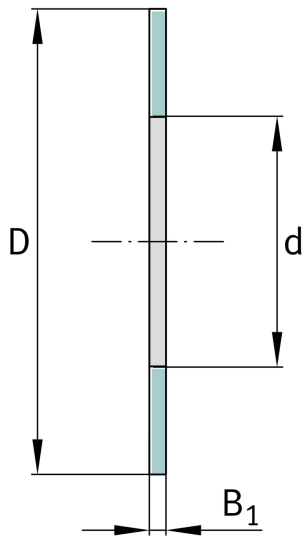

Main Dimensions & Performance Data

d	6 mm	Bore diameter bearing washer
D	19 mm	Outside diameter bearing washer
B ₁	1 mm	Height bearing washer
	1,8 g	Weight