

★ AS130170

Axial bearing washer

Schaeffler ID:
0000198520000

Axial bearing washers, suitable for AXK
and K811, to DIN 5405-3/ISO 303

★ Preferred product

Technical information

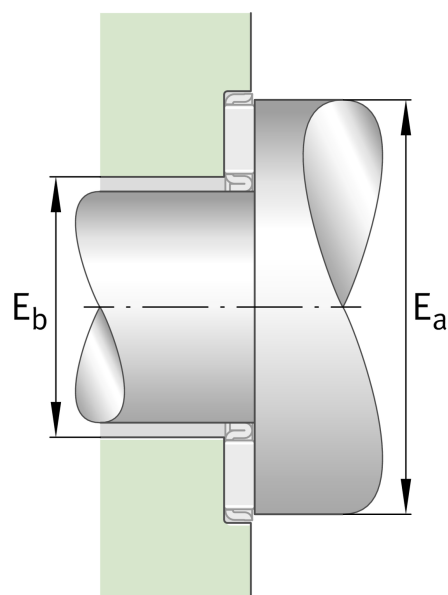
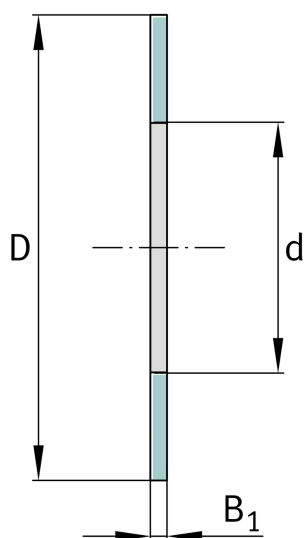

Main Dimensions & Performance Data

d	130 mm	Bore diameter bearing washer
D	170 mm	Outside diameter bearing washer
B ₁	1 mm	Height bearing washer
	69,3 g	Weight