

## ★ NATV20-PP

Yoke type track roller

Schaeffler ID:  
0057127690000

★ Preferred product

Yoke type track rollers NATV...-PP, full complement needle roller set, with axial guidance, axial plain washers on both sides

### Technical information

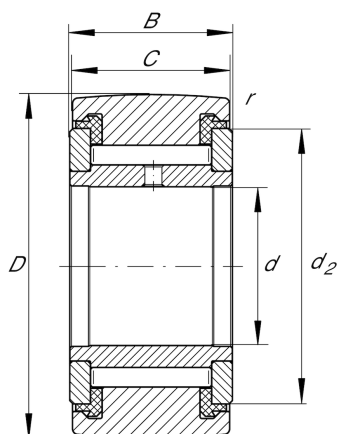

#### Main Dimensions & Performance Data

d	20 mm	Bore diameter
D	47 mm	Outside diameter
B	25 mm	Width, inner ring
$C_{r w}$	20.300 N	Basic dynamic load rating, radial
$C_{0r w}$	42.500 N	Basic static load rating, radial
$C_{ur w}$	6.000 N	Fatigue load limit, radial
$n_{DG}$	1.300 1/min	Speed on permanent grease lubrication
$F_{0r per}$	42.500 N	Permissible static load, radial
$F_{r per}$	42.500 N	Permissible dynamic load outer ring, radial
	0,24 kg	Weight

#### Dimensions

C	24 mm	Width, outer ring
$d_2$	36,5 mm	Outside diameter of thrust washer
$r_{min}$	1 mm	Minimum chamfer dimension