

★ NUTR2562

Yoke type track roller

Schaeffler ID:
0095960460000

★ Preferred product

Yoke type track rollers NUTR, full complement cylindrical roller set, with axial guidance, labyrinth seals on both sides

Technical information

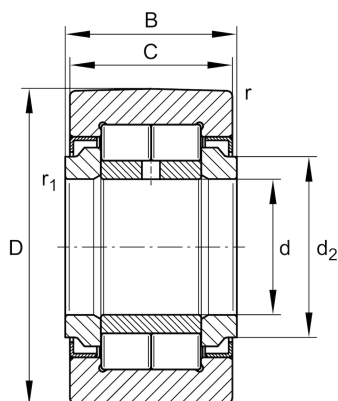

Main Dimensions & Performance Data

d	25 mm	Bore diameter
D	62 mm	Outside diameter
B	25 mm	Width, inner ring
$C_{r w}$	35.500 N	Basic dynamic load rating, radial
$C_{0r w}$	54.000 N	Basic static load rating, radial
$C_{ur w}$	7.000 N	Fatigue load limit, radial
n_{DG}	4.200 1/min	Speed on permanent grease lubrication
$F_{0r per}$	54.000 N	Permissible static load, radial
$F_{r per}$	54.000 N	Permissible dynamic load outer ring, radial
	0,445 kg	Weight

Dimensions

C	24 mm	Width, outer ring
d_2	31 mm	Stop diameter of thrust washer
r_{min}	1 mm	Minimum chamfer dimension
$r_{1 min}$	0,5 mm	Minimum chamfer dimension