

## ★ NUTR35

Yoke type track roller

Schaeffler ID:  
0095960700000

★ Preferred product

Yoke type track rollers NUTR, full complement cylindrical roller set, with axial guidance, labyrinth seals on both sides

### Technical information

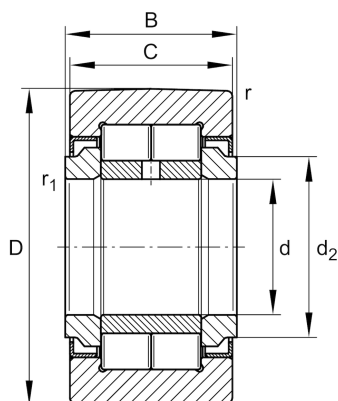

#### Main Dimensions & Performance Data

d	35 mm	Bore diameter
D	72 mm	Outside diameter
B	29 mm	Width, inner ring
$C_{r w}$	45.000 N	Basic dynamic load rating, radial
$C_{0r w}$	66.000 N	Basic static load rating, radial
$C_{ur w}$	8.900 N	Fatigue load limit, radial
$n_{DG}$	2.100 1/min	Speed on permanent grease lubrication
$F_{0r per}$	62.000 N	Permissible static load, radial
$F_{r per}$	31.500 N	Permissible dynamic load outer ring, radial
	0,629 kg	Weight

#### Dimensions

C	28 mm	Width, outer ring
$d_2$	44 mm	Stop diameter of thrust washer
$r_{min}$	1,1 mm	Minimum chamfer dimension
$r_{1 min}$	0,6 mm	Minimum chamfer dimension