



★ FLCTE17-XL

Flanged housing unit

Schaeffler ID:
0008315490000

★ Preferred product

Housing units FLCTE, two-bolt flanged housing units, cast iron, eccentric locking collar, P seals, without relubrication facility

X-life

Technical information

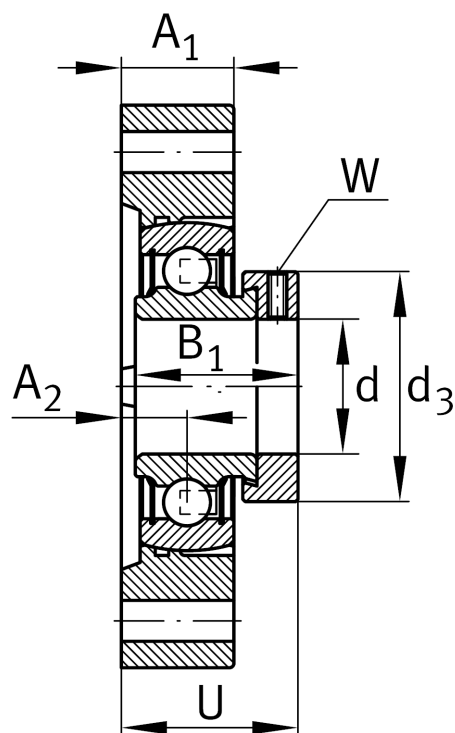
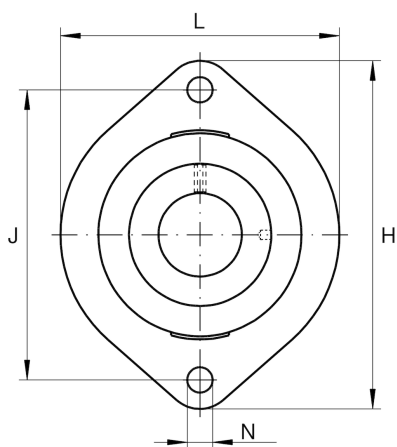

Main Dimensions & Performance Data

d	17 mm	Bore diameter
L	58,7 mm	Flange width
H	81 mm	Height flange
U	30,5 mm	Total height unit
C_r	10.100 N	Basic dynamic load rating, radial
C_{0r}	4.750 N	Basic static load rating, radial
C_{ur}	248 N	Fatigue load limit, radial
	0,3 kg	Weight

Dimensions

A_1	15 mm	Thickness of flange
A_2	8,4 mm	Distance raceway
d_3	28,4 mm	Outside diameter eccentric locking collar

Mounting dimensions

J	63,5 mm	Distance fixing bore
N	6.6 mm	Fixing bore
n	2	Number of screwing holes

Additional information

	1	Number of housings
	LCTE03	Housing
	RAE17-XL-NPP-B	Bearing designation