



★ FLCTEY12-XL

Flanged housing unit

Schaeffler ID:
0009256750000

★ Preferred product

Housing units FLCTEY, two-bolt flanged housing units, cast iron, grub screws in inner ring, P seals, without relubrication facility

X-life

Technical information

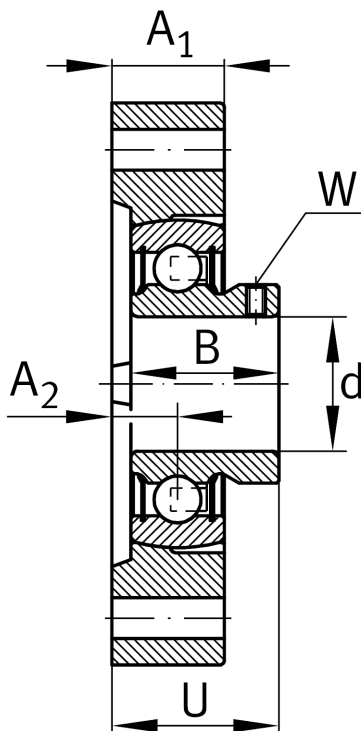
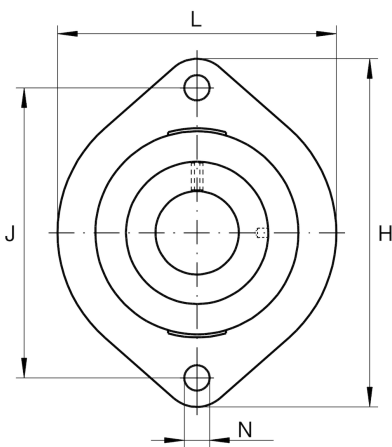

Main Dimensions & Performance Data

d	12 mm	Bore diameter
L	58,7 mm	Flange width
H	81 mm	Height flange
U	24,4 mm	Total height unit
C _r	9.800 N	Basic dynamic load rating, radial
C _{0r}	4.750 N	Basic static load rating, radial
C _{ur}	202 N	Fatigue load limit, radial
	0,28 kg	Weight

Dimensions

A ₁	15 mm	Thickness of flange
A ₂	8,4 mm	Distance raceway
d ₃	28,4 mm	Outside diameter eccentric locking collar

Mounting dimensions

J	63,5 mm	Distance fixing bore
J	63,5 mm	Pitch circle diameter (holes)
N	6.6 mm	Fixing bore
n	2	Number of screwing holes

Additional information

	1	Number of housings
	LCTE03	Housing
	AY12-XL-NPP-B	Bearing designation