

★ 81109-TV

Axial cylindrical roller bearing

Schaeffler ID:
0002403380000

Axial cylindrical roller bearings 811, single direction, comprising K811, GS, WS

★ Preferred product

Technical information

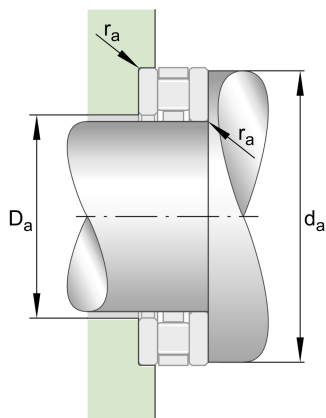
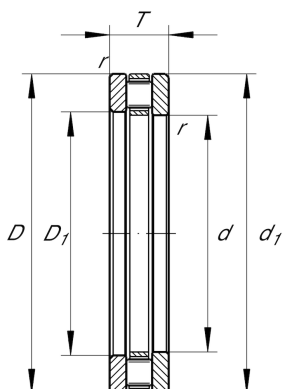

Temperature range

T_{min}	120 °C	Operating temperature min.
T_{max}	-30 °C	Operating temperature max.
	0,001 kg	Weight

Main Dimensions & Performance Data

d	45 mm	Bore diameter
D	65 mm	Outside diameter
T	14 mm	Height
C_a	59.000 N	Basic dynamic load rating, axial
C_{0a}	163.000 N	Basic static load rating, axial
C_{ua}	16.300 N	Fatigue load limit, axial
n_G	5.200 1/min	Limiting speed
n_{gr}	1.970 1/min	Reference speed

Dimensions

D_1	47 mm	Bore diameter housing washer
d_1	65 mm	Rip diameter shaft washer
r_{min}	0,6 mm	Minimum chamfer dimension

Mounting dimensions

$d_{a min}$	63 mm	Minimum diameter shaft shoulder
$D_{a max}$	47 mm	Maximum diameter of housing shoulder
$r_{a max}$	0,6 mm	Maximum recess radius

Additional information

K81109-TV	Axial roller and cage assembly
GS81109	Housing Washer
WS81109	Shaft washer
LS4565	Track Washer