

## ★ 81209-TV

Axial cylindrical roller bearing

Schaeffler ID:  
0006515590000

Axial cylindrical roller bearings 812, single direction, comprising K812, GS, WS

★ Preferred product

### Technical information

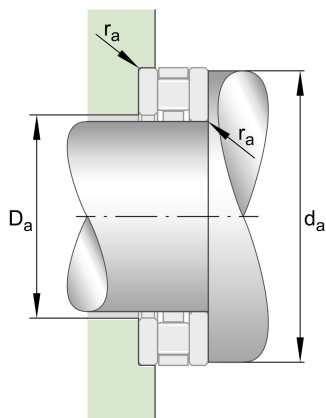
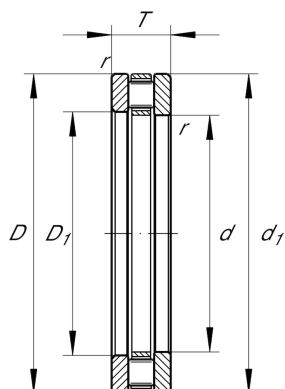

#### Temperature range

$T_{\min}$	-30 °C	Operating temperature min.
$T_{\max}$	120 °C	Operating temperature max.
	0,003 kg	Weight

#### Main Dimensions & Performance Data

d	45 mm	Bore diameter
D	73 mm	Outside diameter
T	20 mm	Height
$C_a$	105.000 N	Basic dynamic load rating, axial
$C_{0a}$	265.000 N	Basic static load rating, axial
$C_{ua}$	23.700 N	Fatigue load limit, axial
$n_G$	4.900 1/min	Limiting speed
$n_{gr}$	1.820 1/min	Reference speed

#### Dimensions

$D_1$	47 mm	Bore diameter housing washer
$d_1$	73 mm	Rip diameter shaft washer
$r_{\min}$	1 mm	Minimum chamfer dimension

#### Mounting dimensions

$d_{a \min}$	70 mm	Minimum diameter shaft shoulder
$D_{a \max}$	48 mm	Maximum diameter of housing shoulder
$r_{a \max}$	1 mm	Maximum recess radius

#### Additional information

K81209-TV	Axial roller and cage assembly
GS81209	Housing Washer
WS81209	Shaft washer
LS6590	Track Washer