

★ KB30

Linear ball bearing

Schaeffler ID:
0012537860000

Linear ball bearings KB., machined range,
corrosion-resistant design possible

★ Preferred product

Technical information

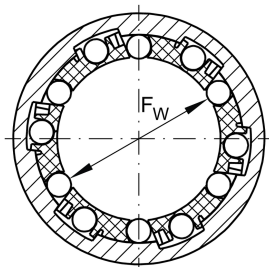
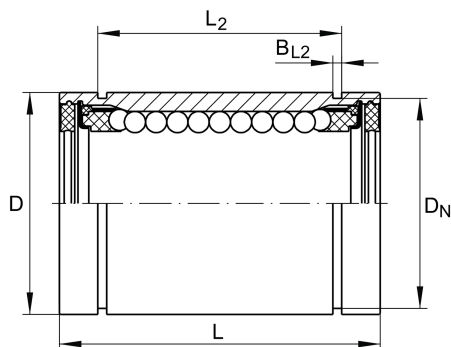

Main Dimensions & Performance Data

F_w	30 mm	Bore diameter of ball complement
	+0,011/-0,001	Tolerance
D	47 mm	Outside diameter
	h5	Tolerance
L	68 mm	length
	h12	Tolerance
C_{min}	3.600 N	load capacity dyn.
C_{0min}	2.850 N	load capacity stat.
C_{max}	3.800 N	load capacity dyn.
C_{0max}	3.600 N	load capacity stat.
	0,254 kg	Weight

Mounting dimensions

L_2	51,7 mm	
	H13	Tolerance
B_{L2}	1,85 mm	
D_N	44,5 mm	
N_2	2,5 mm	
	6	Number of rows balls