

★ NA6907-ZW-XL

Needle roller bearing

Schaeffler ID:
0507441940000

Needle roller bearings NA69...ZW,
Dimension series 69, double row

★ Preferred product

X-life

Technical information

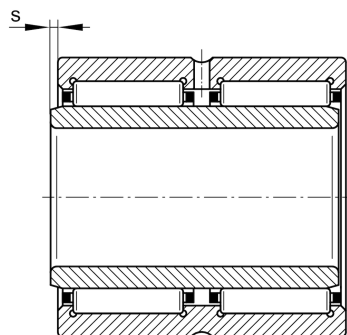
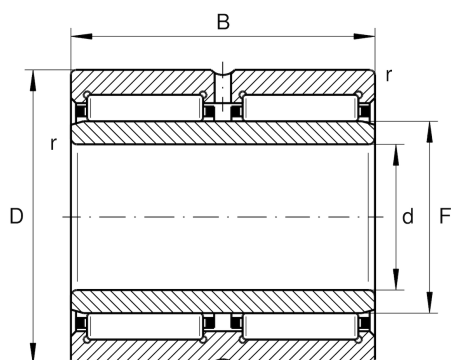

Temperature range

T_{\min}	-30 °C	Operating temperature min.
T_{\max}	120 °C	Operating temperature max.
	0,315 kg	Weight

Main Dimensions & Performance Data

d	35 mm	Bore diameter
D	55 mm	Outside diameter
B	36 mm	Width
C_r	54.000 N	Basic dynamic load rating, radial
C_{0r}	86.000 N	Basic static load rating, radial
C_{ur}	16.200 N	Fatigue load limit, radial
n_G	10.700 1/min	Limiting speed
n_{gr}	5.900 1/min	Reference speed

Dimensions

F	42 mm	Raceway diameter inner ring
r_{\min}	0,6 mm	Minimum chamfer dimension
s	0,5 mm	Axial displacement