



## ★ NKI28/30-XL

Needle roller bearing

Schaeffler ID:  
0507621760000

Needle roller bearings NKI, light series

★ Preferred product

X-life

### Technical information

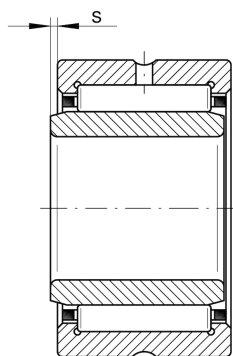
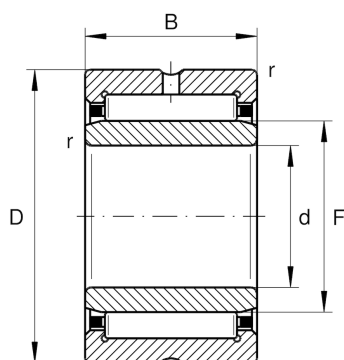

#### Temperature range

$T_{\min}$	-30 °C	Operating temperature min.
$T_{\max}$	120 °C	Operating temperature max.
	0,154 kg	Weight

#### Main Dimensions & Performance Data

d	28 mm	Bore diameter
D	42 mm	Outside diameter
B	30 mm	Width
$C_r$	39.000 N	Basic dynamic load rating, radial
$C_{0r}$	63.000 N	Basic static load rating, radial
$C_{ur}$	11.900 N	Fatigue load limit, radial
$n_G$	14.000 1/min	Limiting speed
$n_{gr}$	7.600 1/min	Reference speed

#### Dimensions

F	32 mm	Raceway diameter inner ring
$r_{\min}$	0,3 mm	Minimum chamfer dimension
s	1,5 mm	Axial displacement