

★ NA4905-2RSR-XL

Needle roller bearing

Schaeffler ID:
0507752190000

Needle roller bearings NA49...2RSR,
dimension series 49, lip seals on both
sides

★ Preferred product

X-life

Technical information

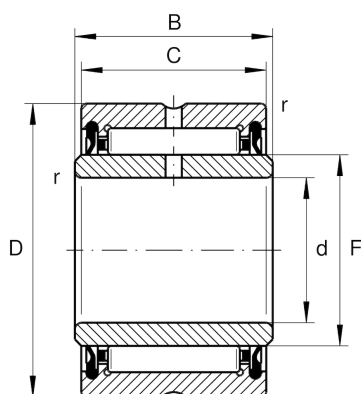

Temperature range

T_{\min}	-20 °C	Operating temperature min.
T_{\max}	100 °C	Operating temperature max.
	0,092 kg	Weight

Main Dimensions & Performance Data

d	25 mm	Bore diameter
D	42 mm	Outside diameter
B	18 mm	Width, inner ring
C_r	21.800 N	Basic dynamic load rating, radial
C_{0r}	24.200 N	Basic static load rating, radial
C_{ur}	4.650 N	Fatigue load limit, radial
$n_{G \text{ Grease}}$	8.600 1/min	Limiting speed for grease lubrication

Dimensions

F	30 mm	Raceway diameter inner ring
C	17 mm	Width, outer ring
r_{\min}	0,3 mm	Minimum chamfer dimension