

## ★ RPNA35/52-XL

Aligning needle roller bearing

Schaeffler ID:  
0507797020000

Aligning needle roller bearings RPNA,  
without inner ring

★ Preferred product

X-life

### Technical information

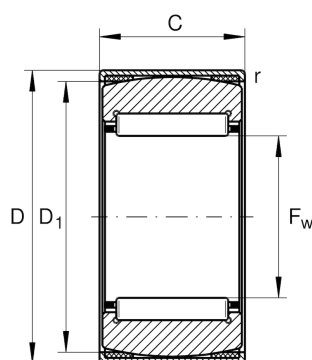

#### Temperature range

$T_{\min}$	-20 °C	Operating temperature min.
$T_{\max}$	100 °C	Operating temperature max.
	0,001 kg	Weight

#### Main Dimensions & Performance Data

$F_w$	35 mm	Under roller diameter
$D$	52 mm	Outside diameter
$C$	20 mm	Width, outer ring
$C_r$	27.500 N	Basic dynamic load rating, radial
$C_{0r}$	41.500 N	Basic static load rating, radial
$C_{ur}$	7.400 N	Fatigue load limit, radial
$n_G$	12.900 1/min	Limiting speed

#### Dimensions

$D_1$	47,5 mm	Flange diameter of outer cup
$r_{\min}$	0,8 mm	Minimum chamfer dimension