

★ RPNA45/62-XL

Aligning needle roller bearing

Schaeffler ID:
0507797370000

Aligning needle roller bearings RPNA,
without inner ring

★ Preferred product

X-life

Technical information

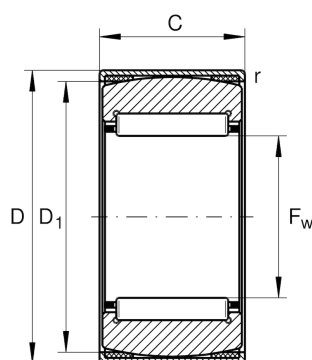

Temperature range

T_{\min}	-20 °C	Operating temperature min.
T_{\max}	100 °C	Operating temperature max.
	0,002 kg	Weight

Main Dimensions & Performance Data

F_w	45 mm	Under roller diameter
D	62 mm	Outside diameter
C	20 mm	Width, outer ring
C_r	31.000 N	Basic dynamic load rating, radial
C_{0r}	53.000 N	Basic static load rating, radial
C_{ur}	9.400 N	Fatigue load limit, radial
n_G	10.200 1/min	Limiting speed

Dimensions

D_1	58 mm	Flange diameter of outer cup
r_{\min}	0,8 mm	Minimum chamfer dimension