

★ AS1528

Axial bearing washer

Schaeffler ID:
0000194610000

Axial bearing washers, suitable for AXK
and K811, to DIN 5405-3/ISO 303

★ Preferred product

Technical information

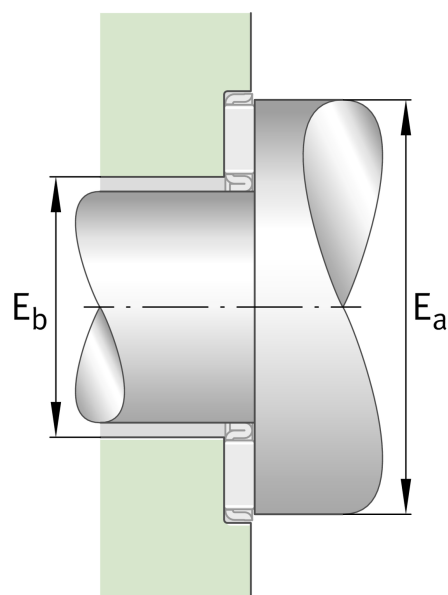
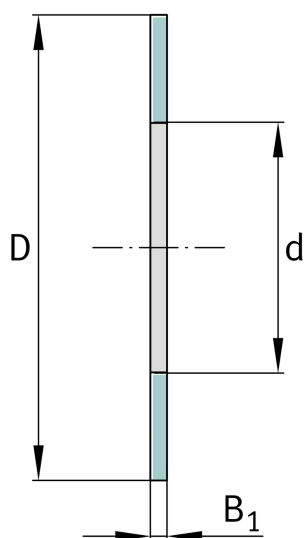

Main Dimensions & Performance Data

d	15 mm	Bore diameter bearing washer
D	28 mm	Outside diameter bearing washer
B ₁	1 mm	Height bearing washer
	3,215 g	Weight