

★ AS4060

Axial bearing washer

Schaeffler ID:
0000195850000

Axial bearing washers, suitable for AXK
and K811, to DIN 5405-3/ISO 303

★ Preferred product

Technical information

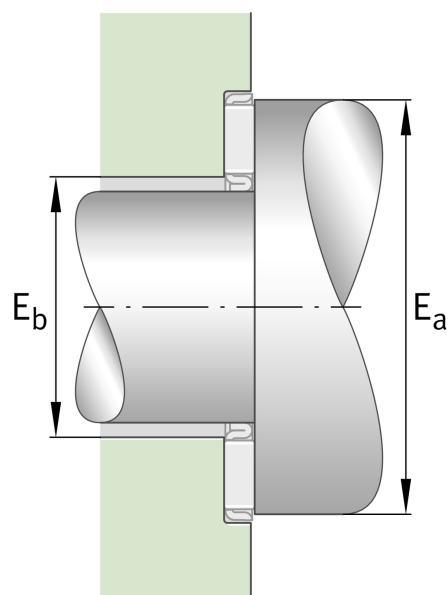
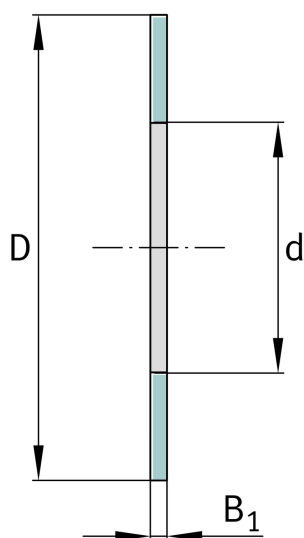

Main Dimensions & Performance Data

d	40 mm	Bore diameter bearing washer
D	60 mm	Outside diameter bearing washer
B ₁	1 mm	Height bearing washer
	11,5 g	Weight